



SMARTEH[®]
LIVING SYSTEMS

USER MANUAL

- Longo programmable controller
LPC-2.DP2BH
Temperature Control panel

Version 1

Written by SMARTEH d.o.o.
Copyright © 2021, SMARTEH d.o.o.

User Manual

Document Version: 1
January, 2021



STANDARDS AND PROVISIONS: Standards, recommendations, regulations and provisions of the country in which the devices will operate, must be considered while planning and setting up electrical devices. Work on 100 .. 240 V AC network is allowed for authorized personnel only.

DANGER WARNINGS: Devices or modules must be protected from moisture, dirt and damage during transport, storing and operation.

WARRANTY CONDITIONS: For all modules LONGO LPC-2 - if no modifications are performed upon and are correctly connected by authorized personnel - in consideration of maximum allowed connecting power, warranty of 24 months is valid from the date of sale to the end buyer, but not more than 36 months after delivery from Smarteh. In case of claims within warranty time, which are based on material malfunctions the producer offers free replacement. The method of return of malfunctioned module, together with description, can be arranged with our authorized representative. Warranty does not include damage due to transport or because of unconsidered corresponding regulations of the country, where the module is installed.

This device must be connected properly by the provided connection scheme in this manual. Misconnections may result in device damage, fire or personal injury.

Hazardous voltage in the device can cause electric shock and may result in personal injury or death.

NEVER SERVICE THIS PRODUCT YOURSELF!

This device must not be installed in the systems critical for life (e.g. medical devices, aircrafts, etc.).

If the device is used in a manner not specified by the manufacturer, the degree of protection provided by the equipment may be impaired.

Waste electrical and electronic equipment (WEEE) must be collected separately!

LONGO LPC-2 complies to the following standards:

- EMC: EN 61000-6-3:2007 + A1:2011, EN 61000-6-1:2007, EN 61000-3-2:2006 + A1:2009 + A2: 2009, EN 61000-3-3:2013
- LVD: IEC 61010-1:2010 (3rd Ed.), IEC 61010-2-201:2013 (1st Ed.)

Smarteh d.o.o. operates a policy of continuous development. Therefore we reserve the right to make changes and improvements to any of the products described in this manual without any prior notice.

MANUFACTURER:

SMARTEH d.o.o.
Poljubinj 114
5220 Tolmin
Slovenia



Index

Longo programmable controller LPC-2.DP2BH

1 DESCRIPTION.....	1
2 FEATURES.....	2
3 OPERATION.....	3
3.1 Operational modes.....	3
3.2 Functions	4
3.3 Parameters.....	5
4 INSTALLATION.....	7
4.1 Connection scheme.....	7
4.2 Mounting frame selection.....	9
4.3 Mounting instructions.....	10
4.4 Module labeling.....	11
5 REGULATION DIAGRAM.....	12
6 TECHNICAL SPECIFICATIONS.....	13
7 CHANGES	14
8 NOTES.....	15



1 DESCRIPTION

LPC-2.DP2BH control panel (CP) is used for room temperature and humidity regulation as radiators, chilled beams, floor heating...

Panel is equipped with temperature and light intensity sensor and four push buttons (PB). To increase, decrease temperature set point *warmer*, *cooler* PB should be pressed respectively. Temperature SP is represented with right LCD bar-graph. While CP is in heating mode (temperature SP is higher than actual room temperature), LCD SP bar is red and while in cooling mode (temperature SP is lower than actual room temperature), LCD SP bar is blue. If actual temperature is in SP +/- Dead band range, LCD SP bar is white.

PB on the left side has the same function as on the right (*warmer*, *cooler* PB).

With ECO (economy), OFF and ERR (error) signs on LCD, CP status is represented.

Color back ground LCD picture is possible to change by using Smarteh LCD Composer software. Light intensity sensor controls LCD intensity.

It is possible to display actual temperature value (0.5 °C resolution) and temperature set point. The real time clock (HH:MM) can also be displayed. Enabling can be done by main module enable commands.

All parameters are accessible on panel's communication port. When panel is connected to the LPC-2 main module parameters can be viewed and modified with LPC Manager application.

LPC-2.DP2BH parameters and functions allows adaptation to desired system and regulation diagram.

Panel is able to regulate 2 or 4-pipe systems, depending on *4/2 pipe* parameter.



2 FEATURES



Figure 1: LPC-2.DP2BH module

Table 1: Features

Room temperature and relative humidity measurement
2+2 push buttons for temperature set point
10 position LCD bar-graph for temperature set point
Light intensity measurement
LCD intensity control
Economic function
2/4 pipe heating cooling system supported
Balcony door and window function
Frost protection function
Color LCD with possibility of back ground picture changing



3 OPERATION

Basic setting can be entered with panel push buttons (PB). Modes of operation and parameters can be set via LPC Manager software, some of them can be also activated through special sequence PB pressing.

It is advised to press push-buttons respectively with finger not faster than 1 press per second.

3.1 Operational modes

LCD Display “stand-by mode”

The display is normally in this mode, if no PB is pressed in last ~5 seconds.

LED intensity is in correlation with Light intensity measurement (more light - brighter, less light - darker).

Actual room temperature (0.5 °C resolution) is shown on the screen if enabled.

LCD Display “SET mode”

First press on any PB will activate the display to “set mode” and LCD intensity will be put to maximum. No action regarding the pressed PB is done. Further pressings on any PB will make the change(bar-graphs) regarding the pressed PB.

Actual temperature set-point (regarding the right bar-graph) is shown on the screen if enabled.

Display will return to “stand-by mode” if push buttons are not pressed for a while (~5 seconds).

Changing operation modes

Request for switching between CP *normal* and *economic* operating mode is done with lower left and right PB pressed simultaneously :
switch to *economic* mode

Request for switching between CP *on* and *off* operating mode is done with upper left and right PB pressed simultaneously :
CP switched *off*

Confirmation of above requested modes is done by main module by changing the appropriate command bit (normal/economic, system on/off).

Normal

This is default mode for DP2BH module. The control algorithm is executing regarding the parameters.

Economy

If set, controller will start cooling when room temperature will raise above max. temperature set-point (SP) and stop when temperature will drop 1 °C below max. temp. SP. On the other hand, when room temperature fall's below min. temp. SP controller will start heating and stop when temperature will raise 1 °C above min. temp. SP.

In economic mode “ECO” sign appear on LCD.

Off



In this mode panel sends command to switch off all devices: hot valve, cold valve. Temperature LCD bar becomes white and “OFF” sign appear on LCD.

CP can be turned off using upper PBs or *System On/Off* command. In this case cool and heat commands are switched off. Cool and heat commands are also switched off when temperature measured by the panel is inside temperature dead band values (default dead band is 0.5 °C).

Error

In case of CP internal on communication fault, “ERR” sign appear on LCD.

Set

When any of four buttons is pressed more than certain time, “SET” sign appear on LCD and buttons functioning is enabled. After “SET” sign is off, push buttons functions are disabled.

3.2 Functions

PI controller

Output variable range is 0 to 10000(0..100%) in heating and/or cooling mode respectively .

Values are used for the output for the heat/cool actuator (0-100% / On-Off valve).

The dynamics of PI calculation is defined by P& I parameters.

Example:

If proportional - P parameter (default = 25) is set to 1 and difference between measured temperature and temperature set point is changed to +1 °C, the PI output value will change from example 5000 to 5100. On the other hand if the difference is changed to -1 °C, PI output value will change from example 5000 to 4900.

If integral - I parameter (default = 5) is set to 1 and difference between measured temperature and temperature set point is +1 °C, the PI output value will increase every second by 1. On the other hand if the difference is -1 °C, the PI output value will decrease every second by 1.

2/4 pipe system selection

While 4-pipe (factory default) system active, controller will activate hot water actuator when heating is required and cool water actuator when cooling is required.

In case 2-pipe system is active, hot water actuator will be operated regardless whether heating or cooling is needed. Mode of operation (closing, opening) is dependent on *Winter/Summer* parameter.

Example:

System selected is 2-pipe , summer mode active and SP is lower than room temperature. CP will start cooling with activating heat valve. In 2-pipe system cool valve is always inactive.

Frost protection

Function activates heat command when room temperature measured by the panel drops below 7 °C. This function has priority over all control panel integrated functions.

Window open

Panel will operate in special mode if opened window and opened balcony door are detected. This function is enabled by enabling parameters *Balcony door En.* or *Window En.* When this function is active and one of parameters *Window* or *Balcony Door* commands is active, the valves for heating and cooling will close (delay of 1 minute is add with Balcony door command).



3.3 Parameters

If parameter is set to logical “1”, is considered to be active, enabled or set. If parameter has logical value “0” is considered to be inactive, disabled, or cleared.

Parameter can be status, command or both. When parameter is marked as status this means that module is sending information to controller. On the other hand, command represents request from main module to module.

Communication: Normal state is “1”. If off, there is communication error or no communication established.

Normal/Economic: When set Economic mode is enabled. Default value is “0” therefore normal mode is selected.

Local/Remote: When “0”, Local mode is selected. In this mode CP uses set point set by PB. In remote mode, “1”, CP uses set point received from other devices (HMI, Touch Panel, OT1, ..) through communication channel.

Heat valve: When valve is opened “1” is reported, while “0” stands for closed valve

Cool valve: When valve is opened “1” is reported, while “0” stands for closed valve

System On/Off: If parameter is set to “0” CP functions are executing in normal mode. If set to “1” the valves are OFF (closed).

Winter/Summer: Used only for *two-pipe system* to change calculation for Hot valve Winter - heating (“0”) to Summer - cooling (“1”)

4/2 pipe: Four-pipe system manages hot and cold water pipes simultaneously. Two-pipe system manages only one pair of pipes (one valve, pump). Operation in two-pipe system is therefore dependent on *Winter/Summer (Change-over)* parameter.

“0” = Four pipe system

“1” = Two pipe system

Balcony door En.: When switch for detecting opened balcony door is connected to the system, this function should be enabled (“1”).

Balcony door switch: Parameter reports whether door are closed or opened

“1”: closed

“0”: opened

Window En.: When switch for detecting opened window is connected to the system, this function should be enabled (“1”).

Window switch: Parameter reports whether window is closed or opened

“1”: closed

“0”: opened

Max. temp.: denotes max. SP temp. which is scaled to top of LCD temperature bar

Min. temp.: denotes min. SP temp. which is scaled to bottom of LCD temperature bar

P regulation par.: Proportional parameter for PI calculation algorithm on CP

I regulation par.: Integral parameter for PI calculation algorithm on CP

PI Dead band: Value of change for PI loop output.

Temp. SP: This value is taken into PI calculation algorithm

Room temp.: Room temperature measured by CP panel.

Auxiliary room temp.: Room temperature value from other sensor is taken into PI calculation as



room temperature instead of temp. value measured by CP panel.

Light intensity: Actual light intensity measured by sensor on CP

Min. light intensity: When *Light intensity* is lower than this parameter, LCD bar graph on CP turns off

Remote temp. SP: When *Local/Remote* parameter is active this parameter is taken into PI calculation algorithm as SP.

SP up: When this command changes to active, CP will increment SP for 1/10 of scale. It acts like pressing on *Warmer PB* on CP.

SP down: When this command changes to active, CP will decrement SP for 1/10 of SP range. It acts like pressing on *Cooler PB* on CP.

Real Time clock: Real time clock (HH:MM) value by main module for display on CP panel. Displaying is enabled with *RTC Enable* command bit.

Temp. display Enable: If this command is active, displaying of actual Room temperature on the CP panel is enabled.

PB pressed: This parameter indicates that any of PB is pressed.

Hum. display Enable: If this command is active, displaying of actual rel. humidity on the CP panel is enabled.

Room Rel.humidity: This parameter indicates actual relative humidity in the room.



4 INSTALLATION

4.1 Connection scheme

Figure 2: Connection scheme

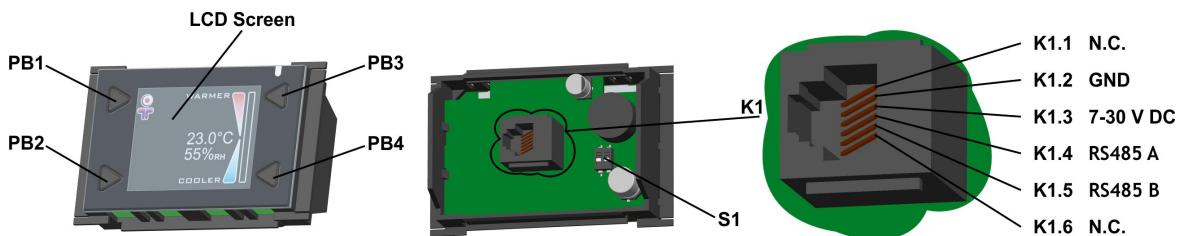
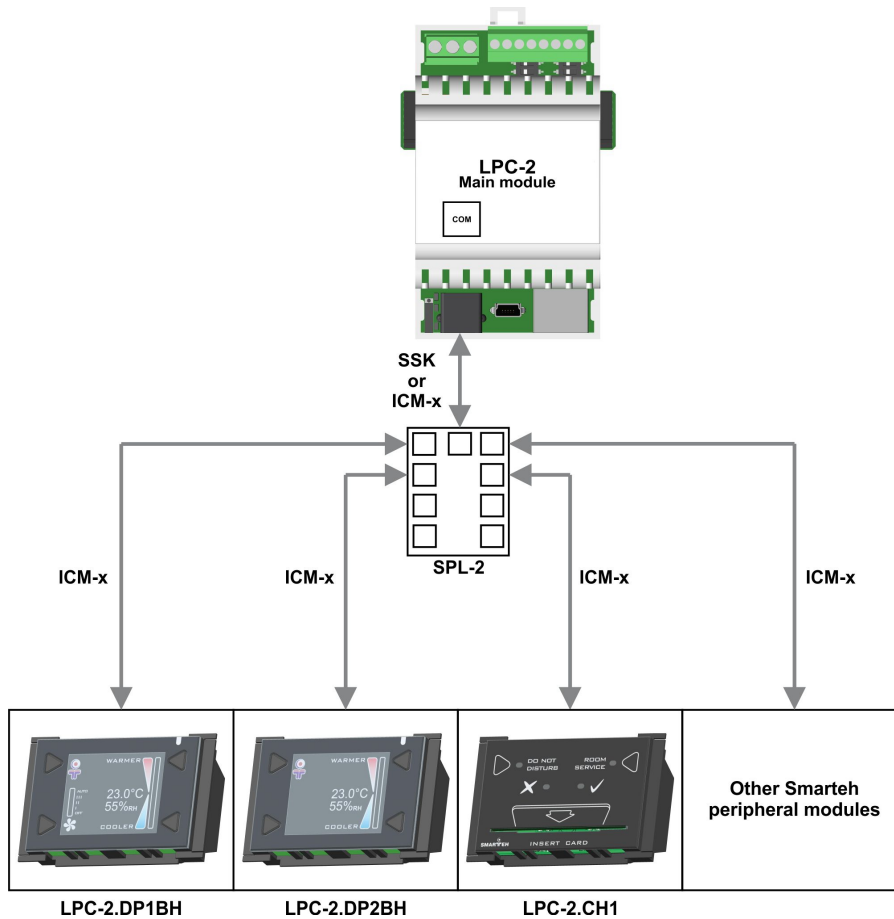

Table 2: K1

K1.1	N.C.	
K1.2	GND	Ground
K1.3	7 .. 30 V DC	Power supply input
K1.4	Standard RS-485 A	Data receive/send line A
K1.5	Standard RS-485 B	Data receive/send line B
K1.6	N.C.	

Table 3: LCD bars & Buttons

Bar 1 LCD	Temp. SP	Active LCD bar presents actual set point relative to range <i>Min. temp.</i> (bottom LCD bar) - <i>Max. temp.</i> (top LCD bar)
PB1/PB3	Temp. SP Up	Increase by one step, step = $(Max. temp - Min. temp) * 1/10$
PB2/PB4	Temp. SP Down	Decrease by one step, step = $(Max. temp - Min. temp) * 1/10$

Table 4: S1

RS-485 ADDRESS	Switch 1	Switch 2
0	OFF	OFF
1	OFF	ON
2	ON	OFF
3	ON	ON

Interconnection cable can ordered from Smarteh or terminated on site, considering wiring scheme bellow:

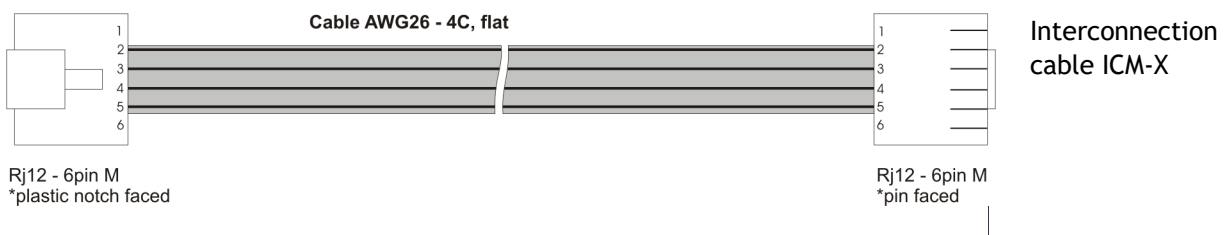

4.2 Mounting frame selection

SmarteH has verified following lines to be compatible with LPC-2.DP2BH module:

- Bticino - Living, Light
- Gewiss - Playbus, System
- Vimar - Plana, Idea
- Tem - Modul Soft, Modul Line
- Master

Frames of other vendors most probably suits as well, but they were not verified by SmarteH. Before installation verify compatibility of non listed frames.

Module housing has a fin on each side, which can be easily removed with knife cutter or pliers. This adaptation enables housing to be build in various frame formats with two different depths. With regard to frame used you may remove fin for housing to fit in.

NOTE: LPC-2.DP1H module should be installed into the wall mounted housing frames, allowing correct temperature reading regarding temperature calibration.

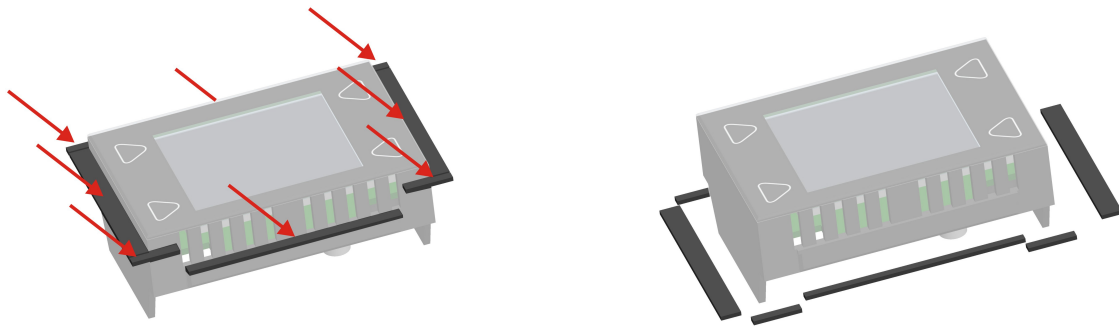

4.3 Mounting instructions

Figure 3: Housing dimensions

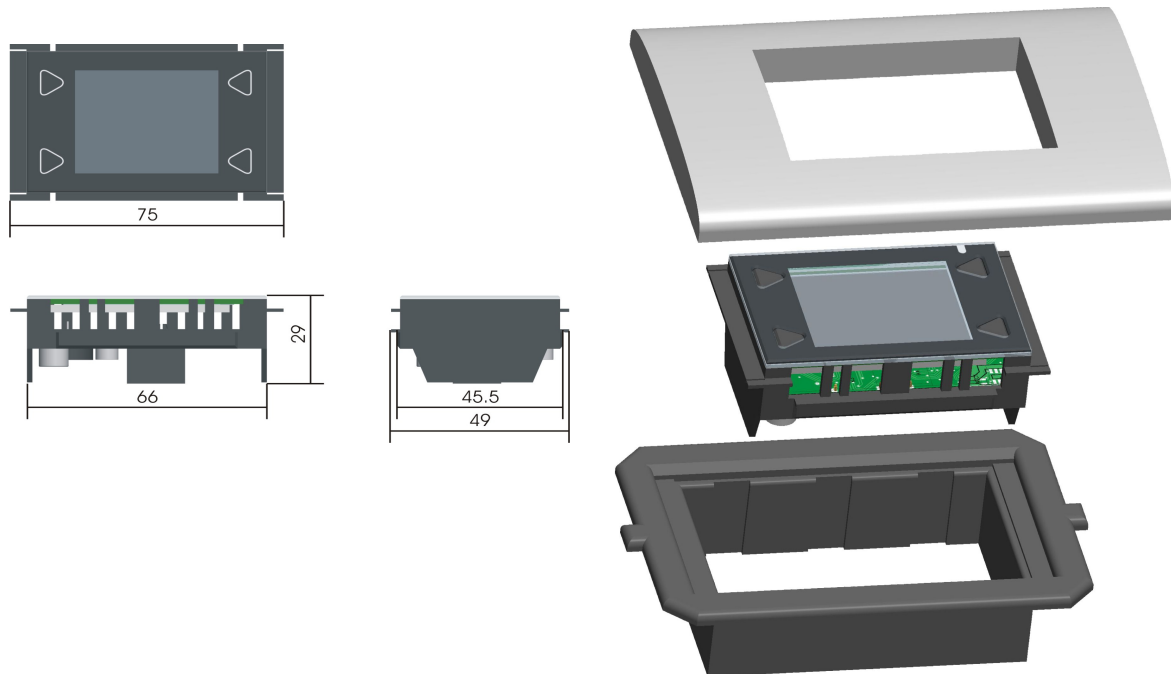

Dimensions in millimeters.



All connections, module attachments and assembling must be done while module is not connected to the main power supply. Module should be positioned in the wall inside of the room. Avoid direct sunlight or positioning near heating/cooling source object. Usage of cover frames and holders made of metal, could cause the decreased performance of push buttons.

Junction box and tubes in the wall must be sealed to prevent airflow. Displayed temperature is adequate to temperature approx. 10 cm below module and 1 cm off the wall.

Recommended installation height is 1.5 m above floor level.

1. Set the correct RS-485 address (S1 switch) for LPC-2.DP2BH (refer to the Table 4).
2. Connect interconnection cable to the connector K1. Max. allowed tensile force is 30 N.
3. Put the LPC-2.DP2BH in mounting frames
4. Cover LPC-2.DP2BH with cover plate

LPC-2.DP2BH is connected to the main module with interconnection cable (e.g., SSK, ICM-7) which must be ordered together with LPC-2.DP2BH module. When more modules (e.g., LPC-2.CR1, LPC-2.CH1, LPC-2.DP1V or up to four LPC-2.DP2) are connected to main module, splitter (e.g., SPL-2) is also required (Figure 2).

Module address on RS-485 network is set with DIP switch on the back of the module (Table 4).

NOTE: Signal wires must be installed separately from power and high voltage wires in accordance with general industry electrical installation standard.



4.4 Module labeling

Figure 4: Label

Label (sample):

```
XXX-N.ZZZ  
P/N: AAABBBCCDDDEEE  
S/N: SSS-RR-YYXXXXXXXXXX  
D/C: WW/YY
```

Label description:

1. **XXX-N.ZZZ** - full product name.
 - **XXX-N** - Product family
 - **ZZZ** - product
2. **P/N: AAABBBCCDDDEEE** - part number.
 - **AAA** - general code for product family,
 - **BBB** - short product name,
 - **CCDDD** - sequence code,
 - **CC** - year of code opening,
 - **DDD** - derivation code,
 - **EEE** - version code (reserved for future HW and/or SW firmware upgrades).
3. **S/N: SSS-RR-YYXXXXXXXXXX** - serial number.
 - **SSS** - short product name,
 - **RR** - user code (test procedure, e.g. Smarteh person xxx),
 - **YY** - year,
 - **XXXXXXXXXX** - current stack number.
4. **D/C: WW/YY** - date code.
 - **WW** - week and
 - **YY** - year of production.

Optional

1. **MAC**
2. **Symbols**
3. **WAMP**
4. **Other**



5 REGULATION DIAGRAM

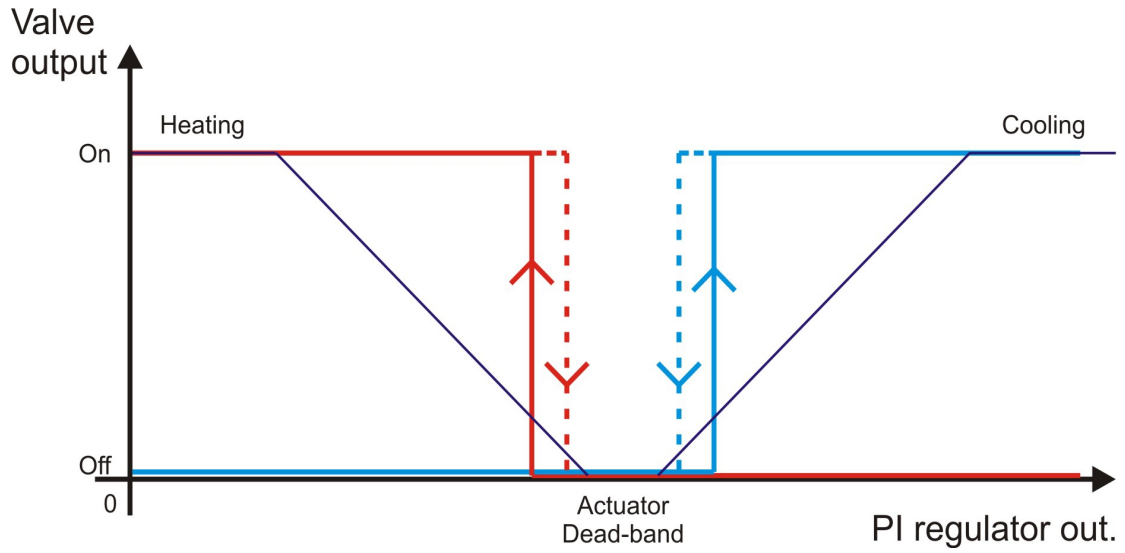
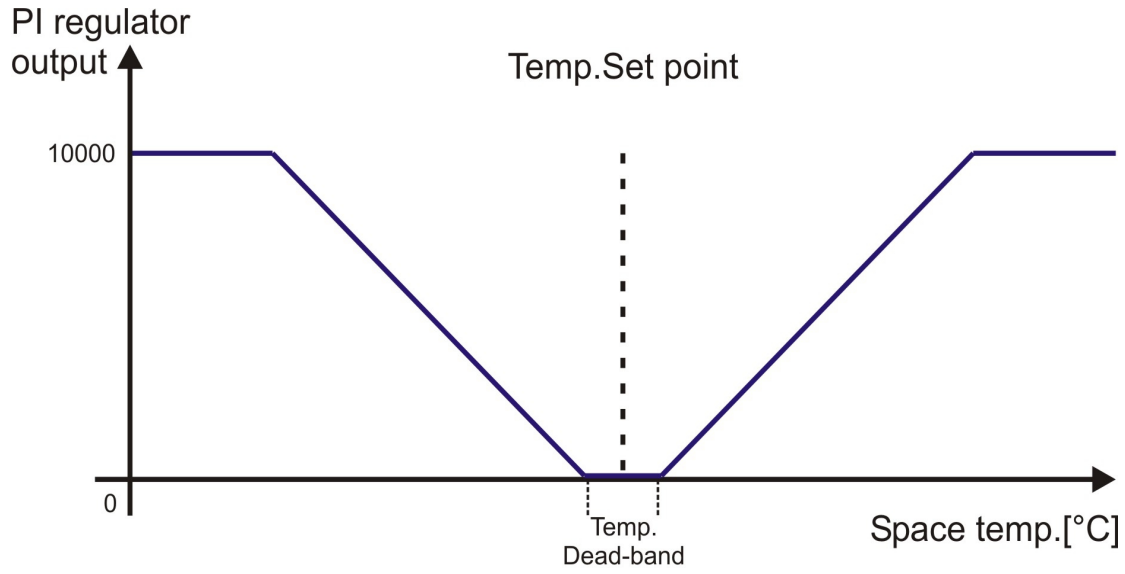

6 TECHNICAL SPECIFICATIONS

Table 5: Technical specifications

Power supply	from main module
Interconnection connector type	RJ-12 6/6
Power consumption	1 W
Dimensions (W x H x D)	75 x 49 x 29 mm
Weight	50 g
Maximum altitude	2000 m
Mounting position	horizontal
Ambient temperature	0 to 50 °C
Ambient humidity	max. 95 %, no condensation
Transport and storage temperature	-20 to 60 °C
Protection class	IP 20



7 CHANGES

The following table describes all the changes to the document.

Date	Ver.	Description
18.01.2021	1	The initial version, issued as <i>LPC-2.DP2BH module UserManual</i> .



8 NOTES

